

1-2 Bellaguarda, Urnengrab; 3 Mitópoli, Grab; 4-6 Lipari, Akropolis (Capo Graziano 2);
7-8 Lipari, Akropolis (Milazzese); 9-12 Filicudi (Capo Graziano 2). M. 1:3

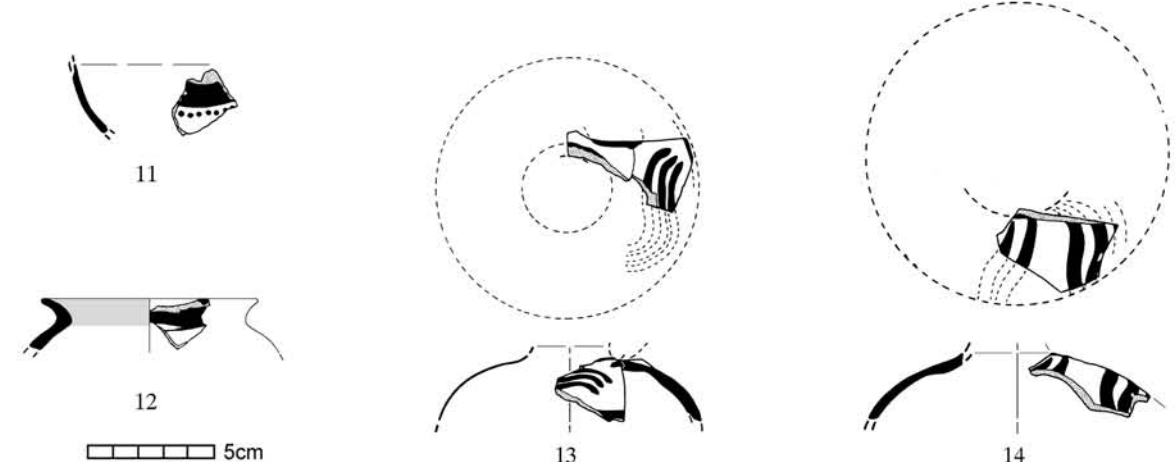

1-2 Filicudi (Capo Graziano 2); 3-5 Vivara, Punta di Mezzogiorno (MBZ 1);
6-14 Vivara, Punta d'Alaca (MBZ 2). M. 1:3

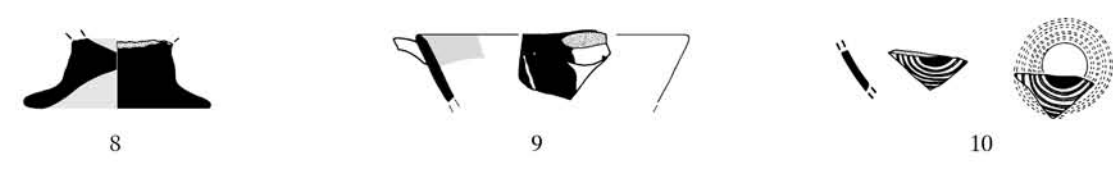
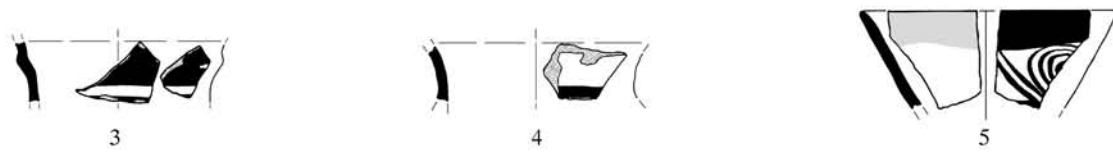
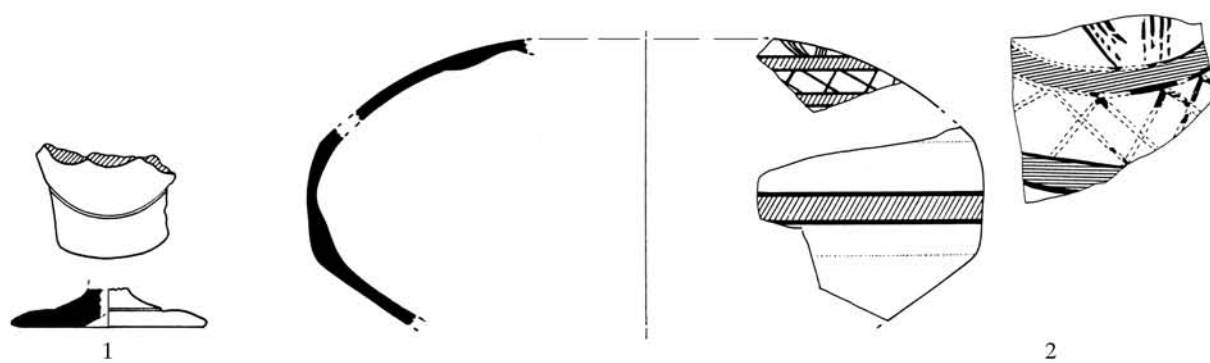
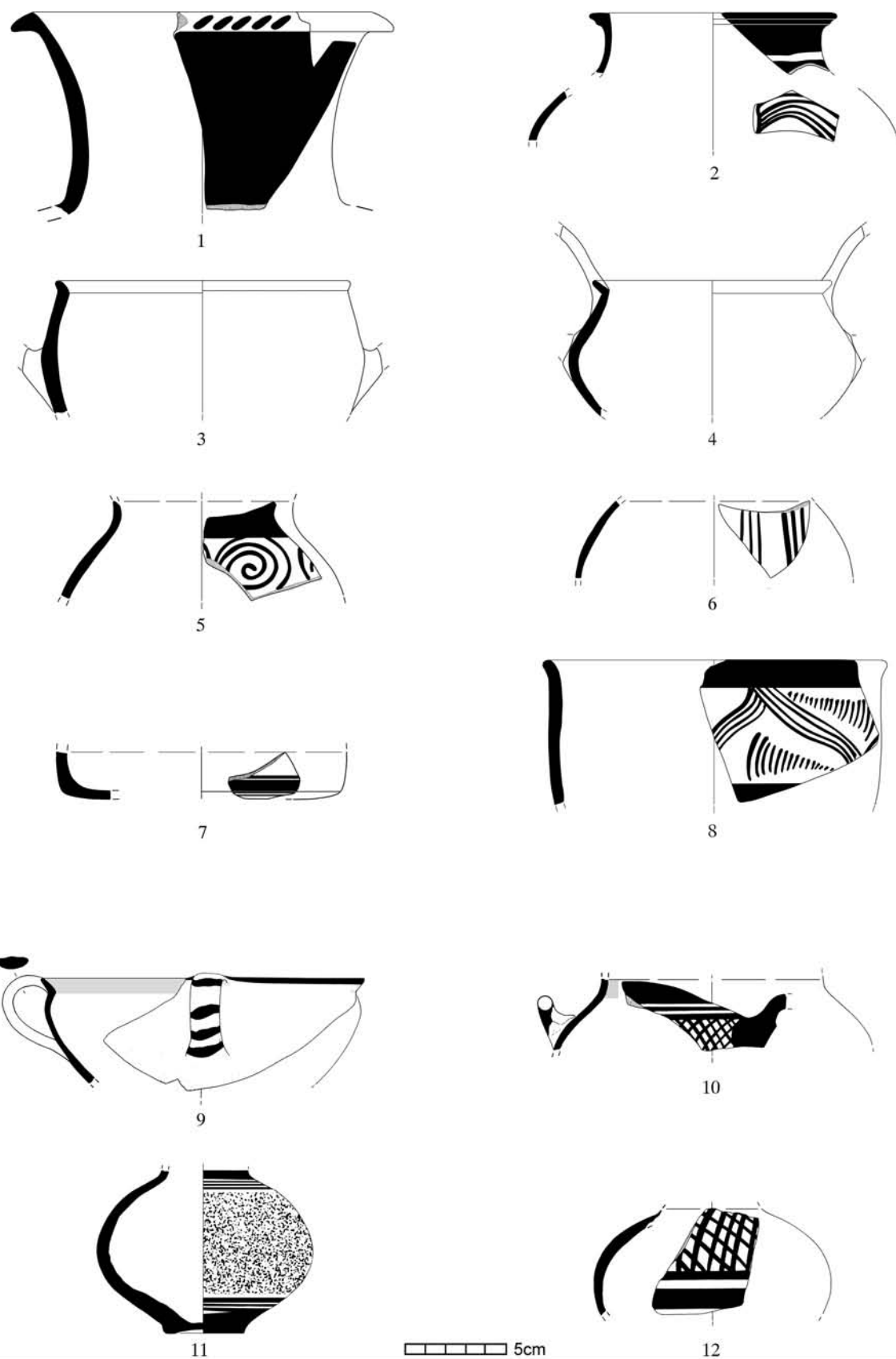

1–4 Rocavecchia (MBZ 2); 5–8 Rocavecchia (MBZ 3); 9 Punta Le Terrare (MBZ 2);
10–12 Punta Le Terrare (MBZ 3). M. 1:3

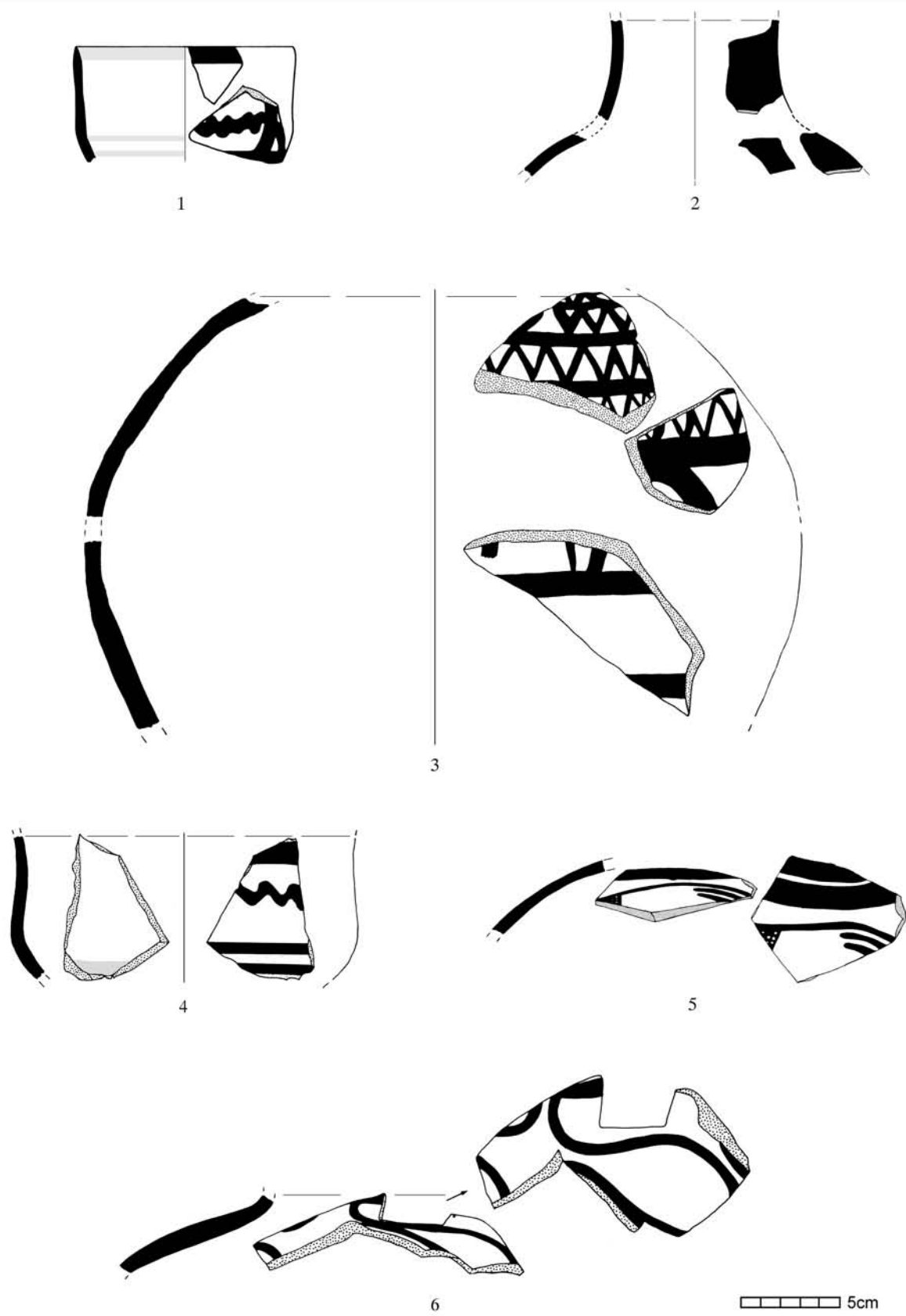

1-3 Broglio di Trebisacce (JBZ 1); 4-6 Broglio di Trebisacce (JBZ 2). M. 1:3

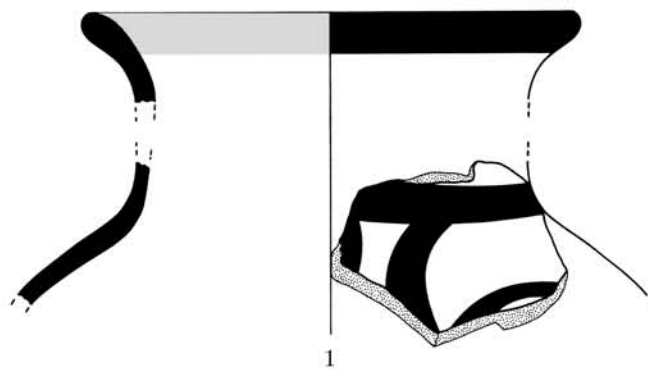

1

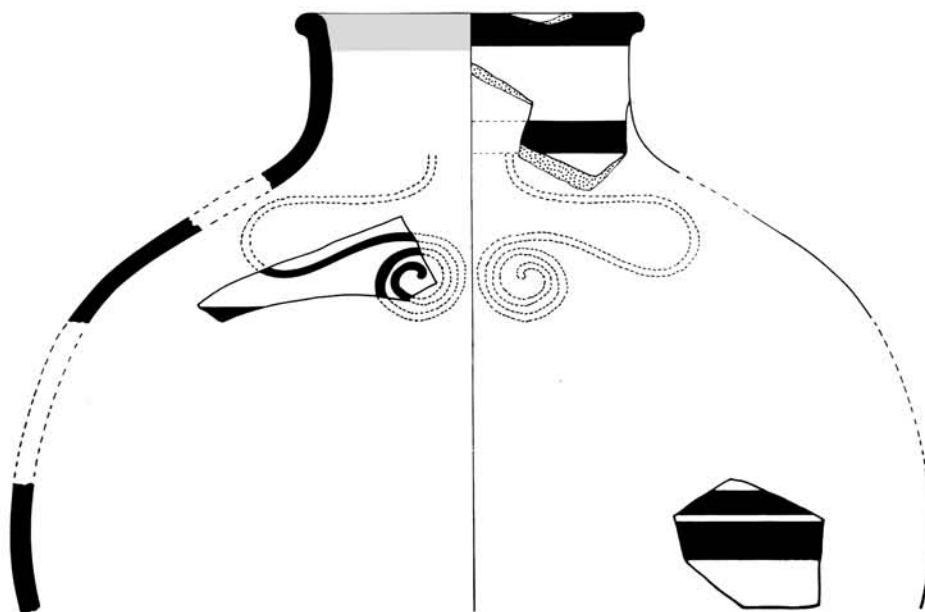

2

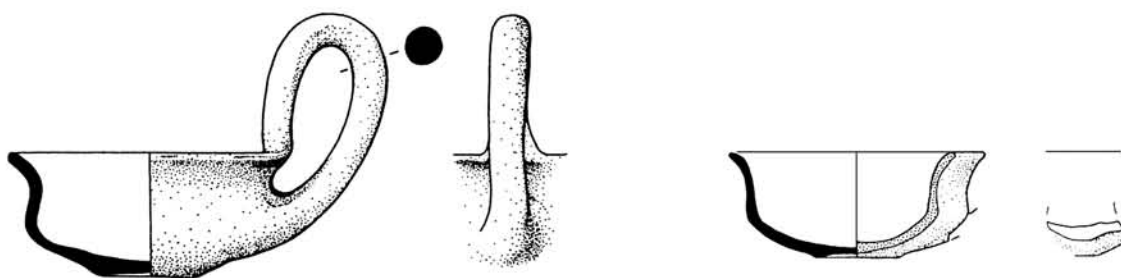

3

5cm

4

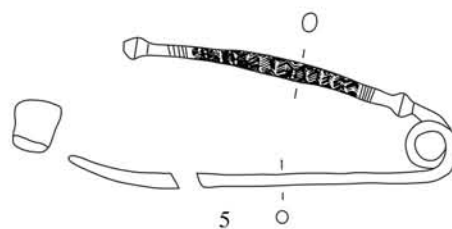

5

5cm

1-5 Broglio di Trebisacce (JBZ 2). 1-4 M. 1:3; 5 M. 1:2

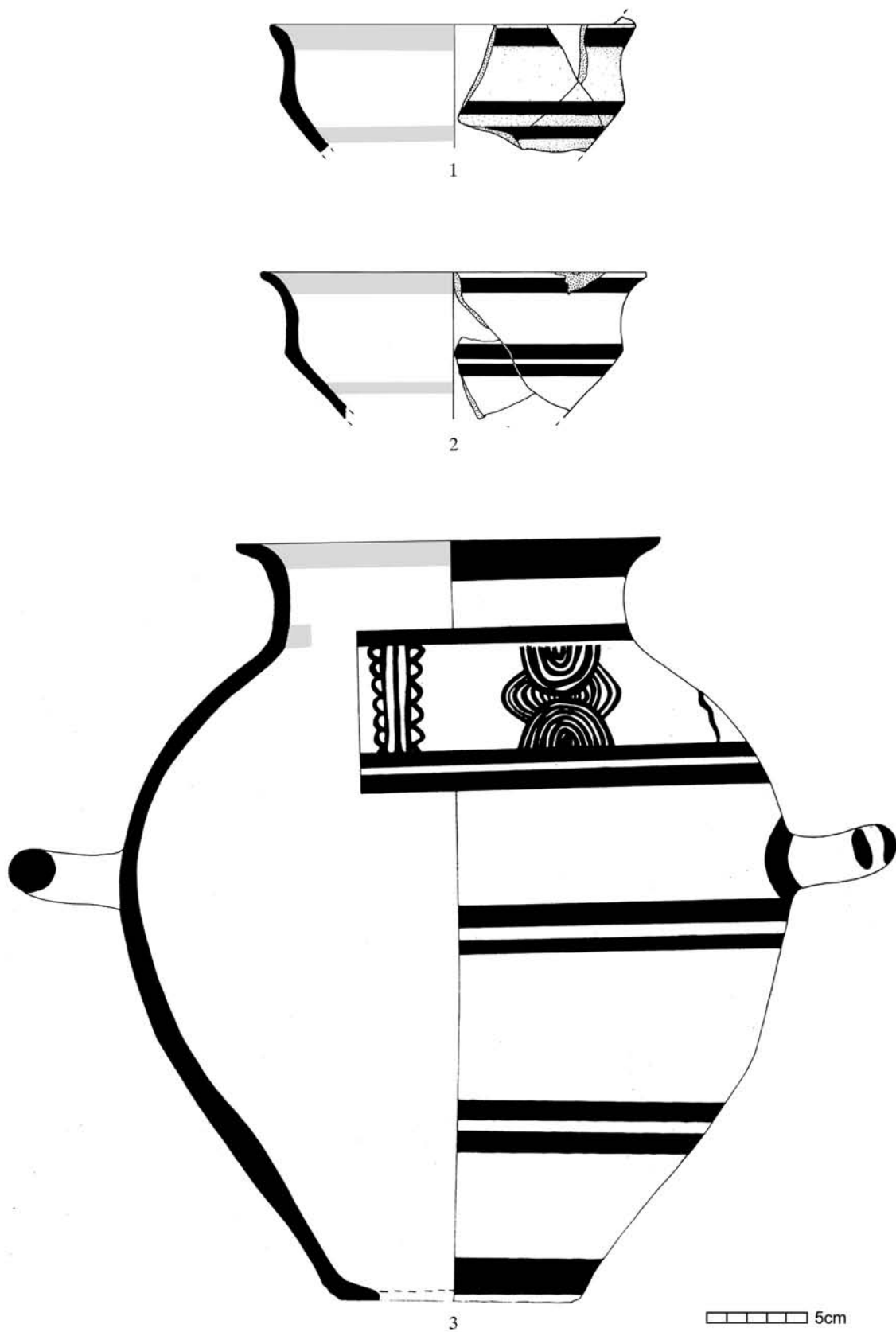

1 Broglio di Trebisacce; 2-3 Broglio di Trebisacce (JBZ 2). M. 1:3

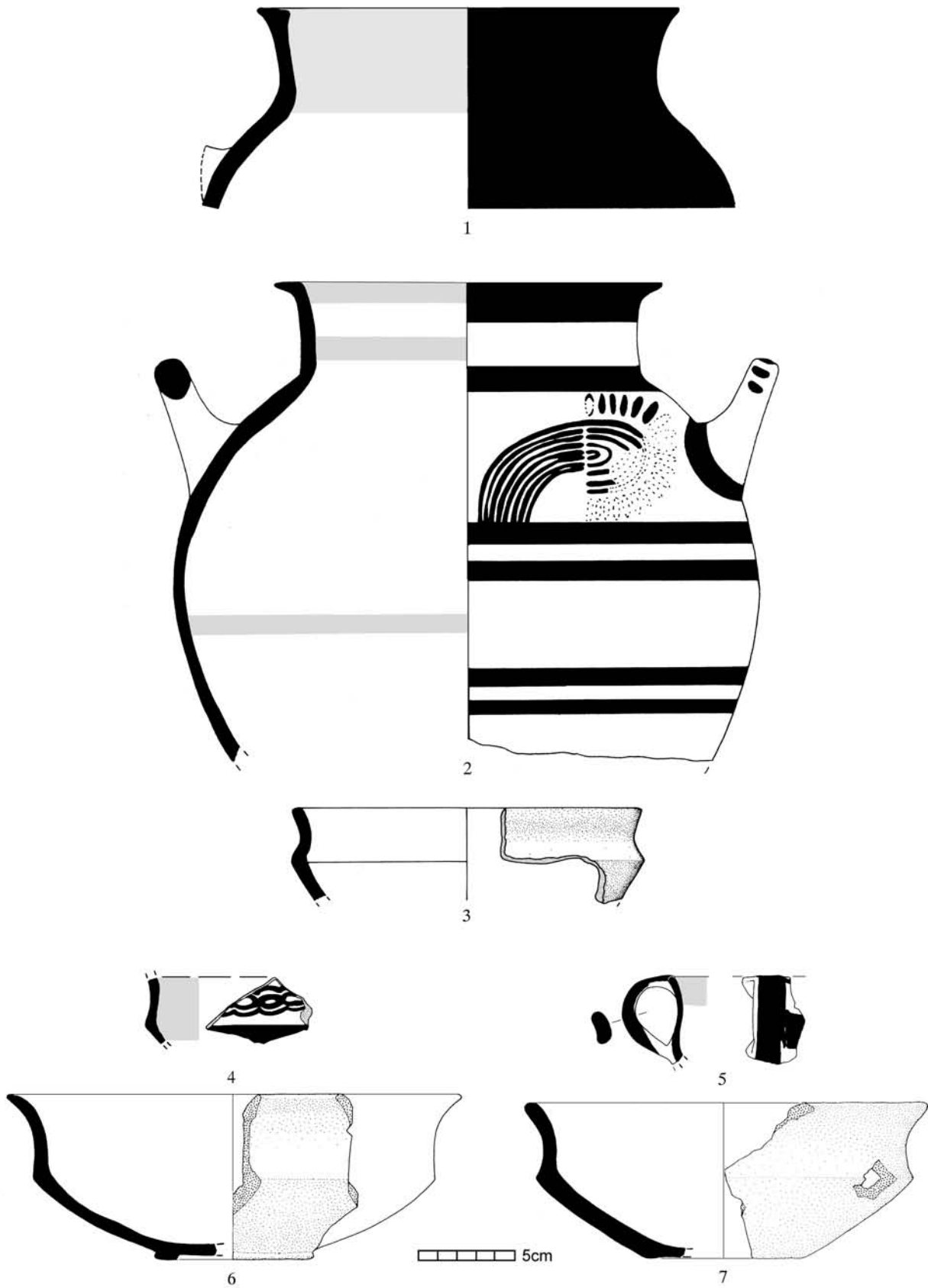

1 Äjira, Phase 1a; 2 Broglio di Trebisacce (JBZ 2); 3 Broglio di Trebisacce (EBZ 2); 4-5. 7 Torre Mordillo (JBZ 2);
6 Torre Mordillo (JBZ 1). M. 1:3

TAFEL 8

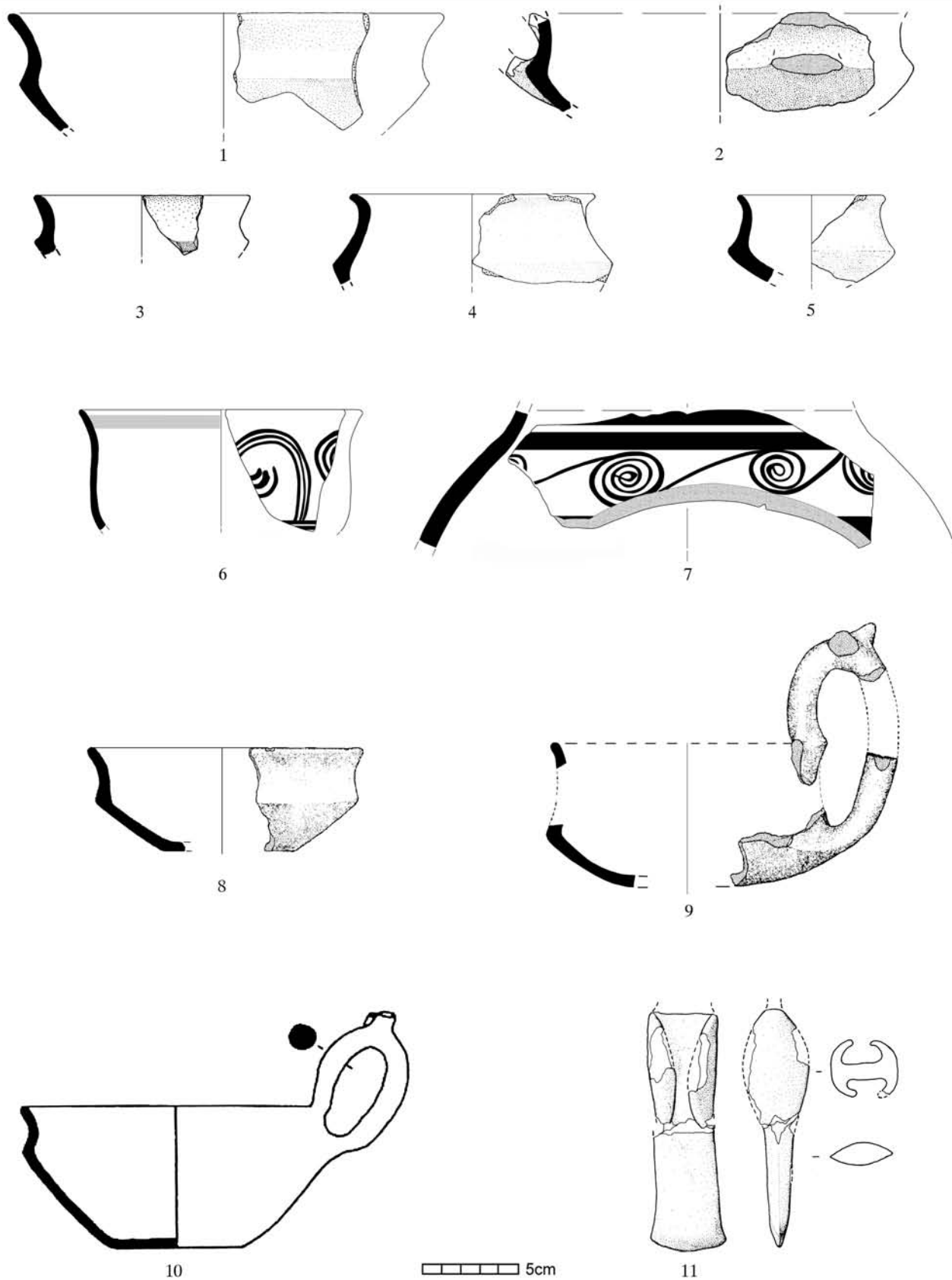

1 Torre Mordillo (JBZ 2); 2-3 Torre Mordillo (EBZ 1); 4-5 Torre Mordillo (EBZ 1-2); 6-7 Rocavecchia (JBZ);
8-9 Torre Santa Sabina (JBZ 2); 10 Cirò Marina (JBZ-EBZ); 11 Coppa Nevigata (JBZ 1). M. 1:3

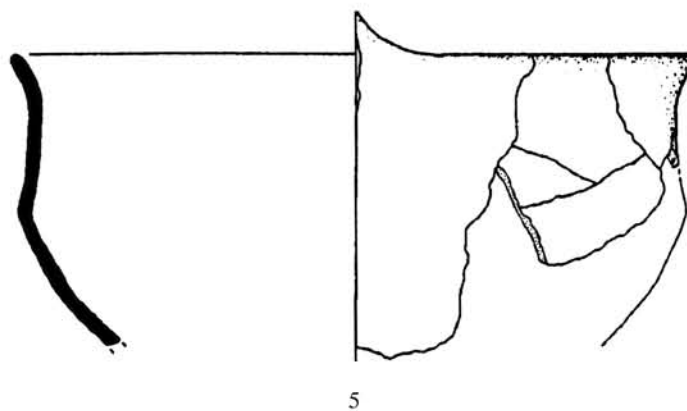
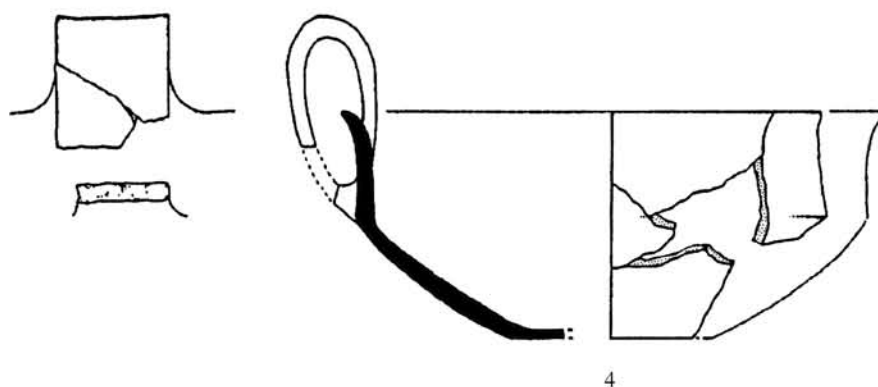
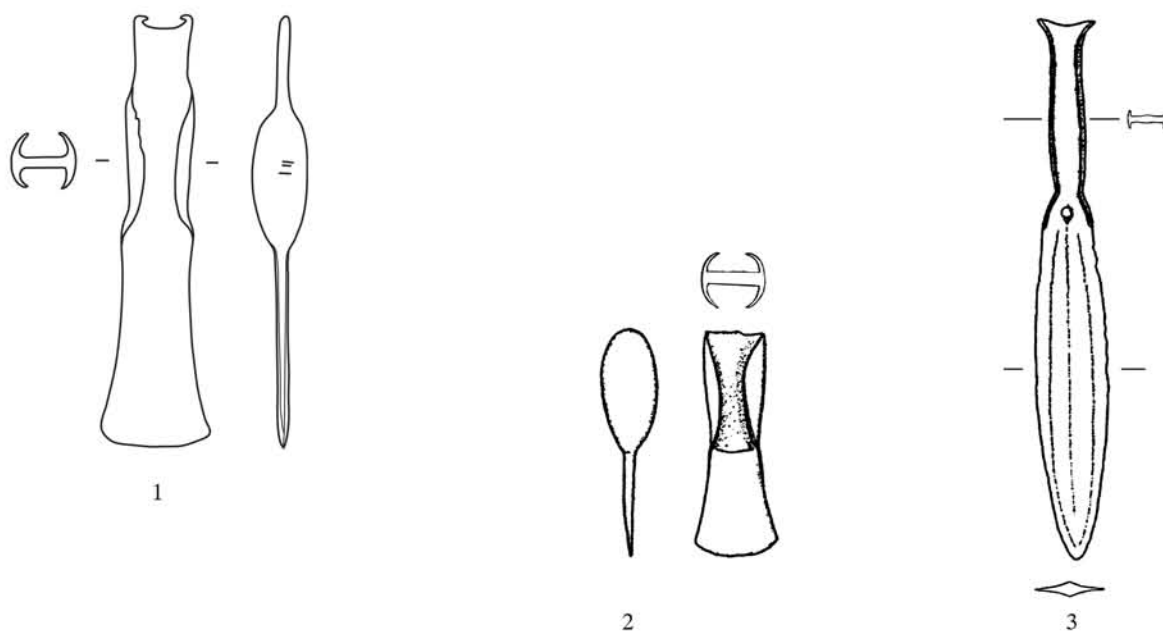

5cm

1 Surbo (JBZ 2); 2-5 Moscosi di Cingoli, Phase 4. M. 1:3

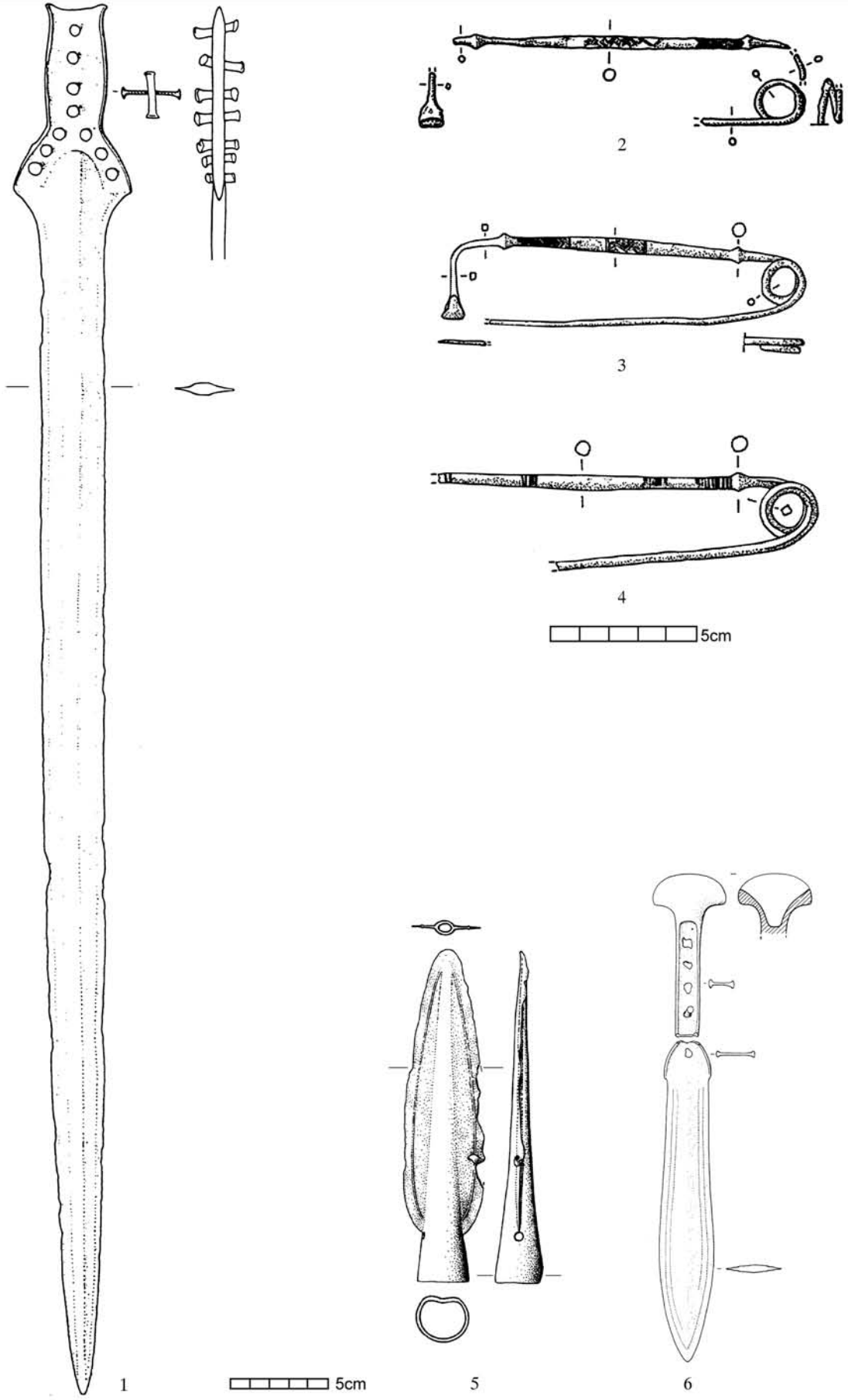

1 Olmo di Nogara (JBZ 1); 2-4 Cavallo Morto (JBZ 2); 5-6 Pila del Brancón (JBZ 2/EBZ 1).
1. 5-6 M. 1:3; 2-4 M. 1:2

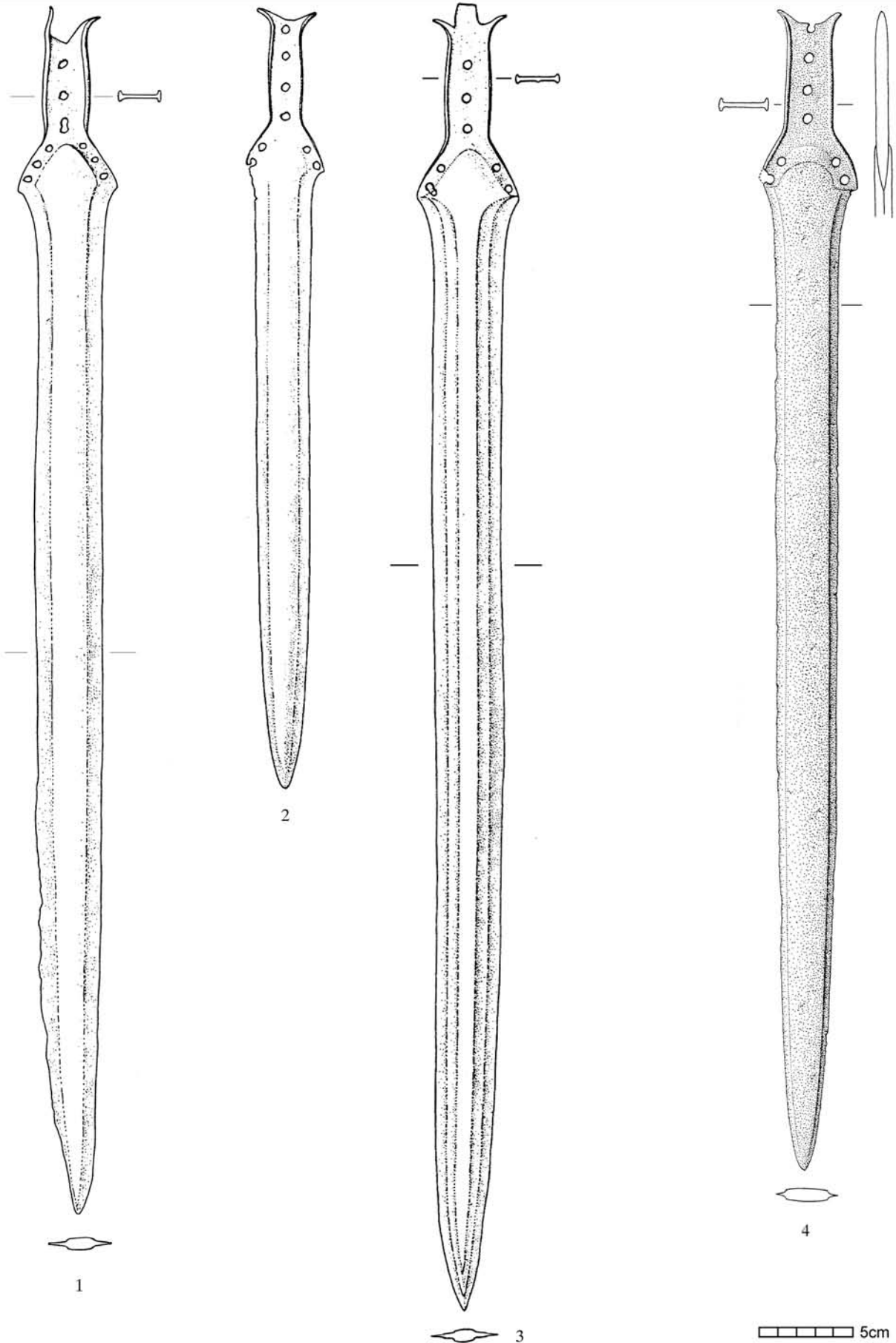

1-3 Pila del Brancón (JBZ 2/EBZ 1); 4 Vibo Valentia (JBZ). M. 1:3

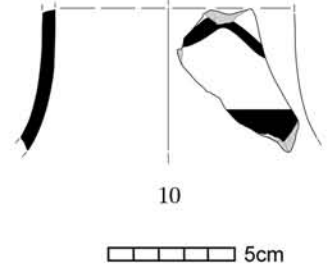
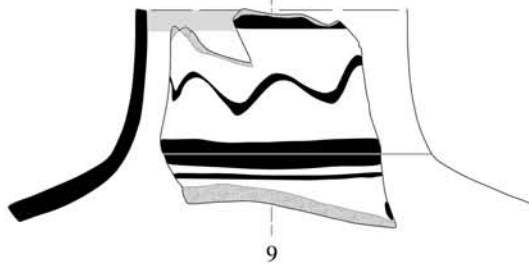
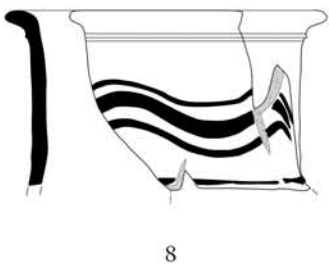
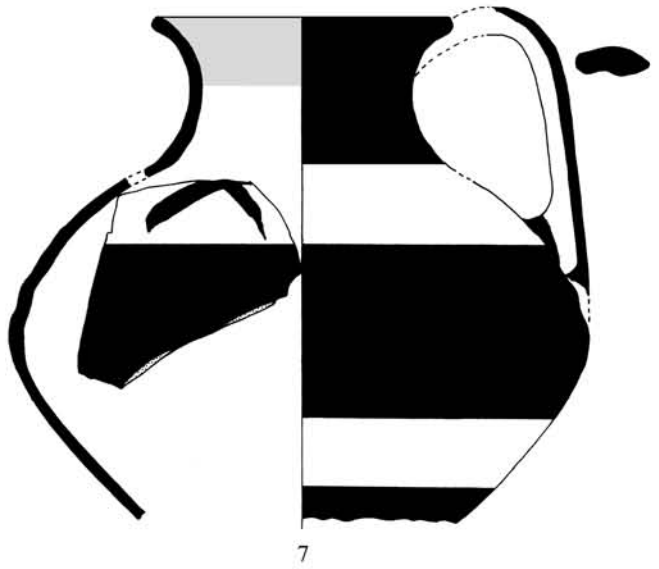
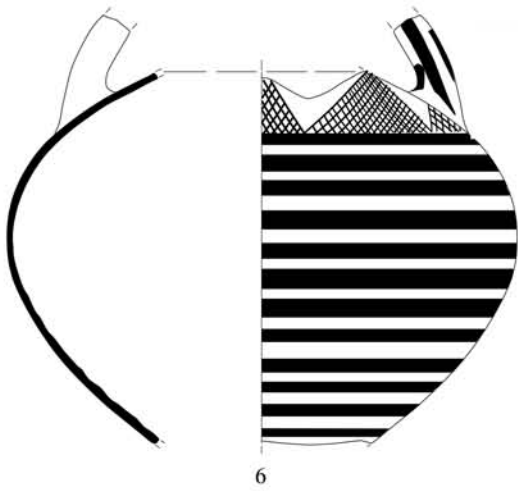
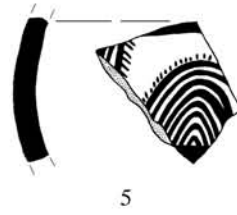
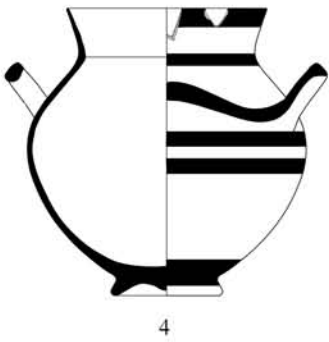
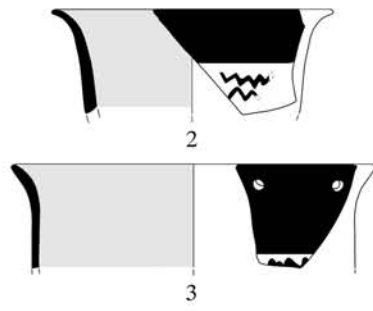
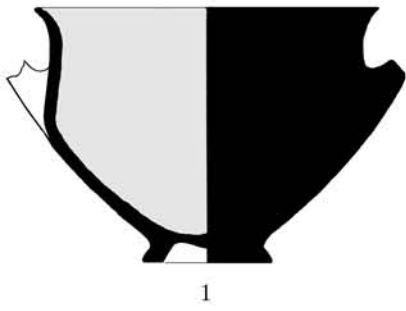

5cm

1-7 Rocavecchia (EBZ 2); 8-10 Rocavecchia (EBZ). M. 1:3

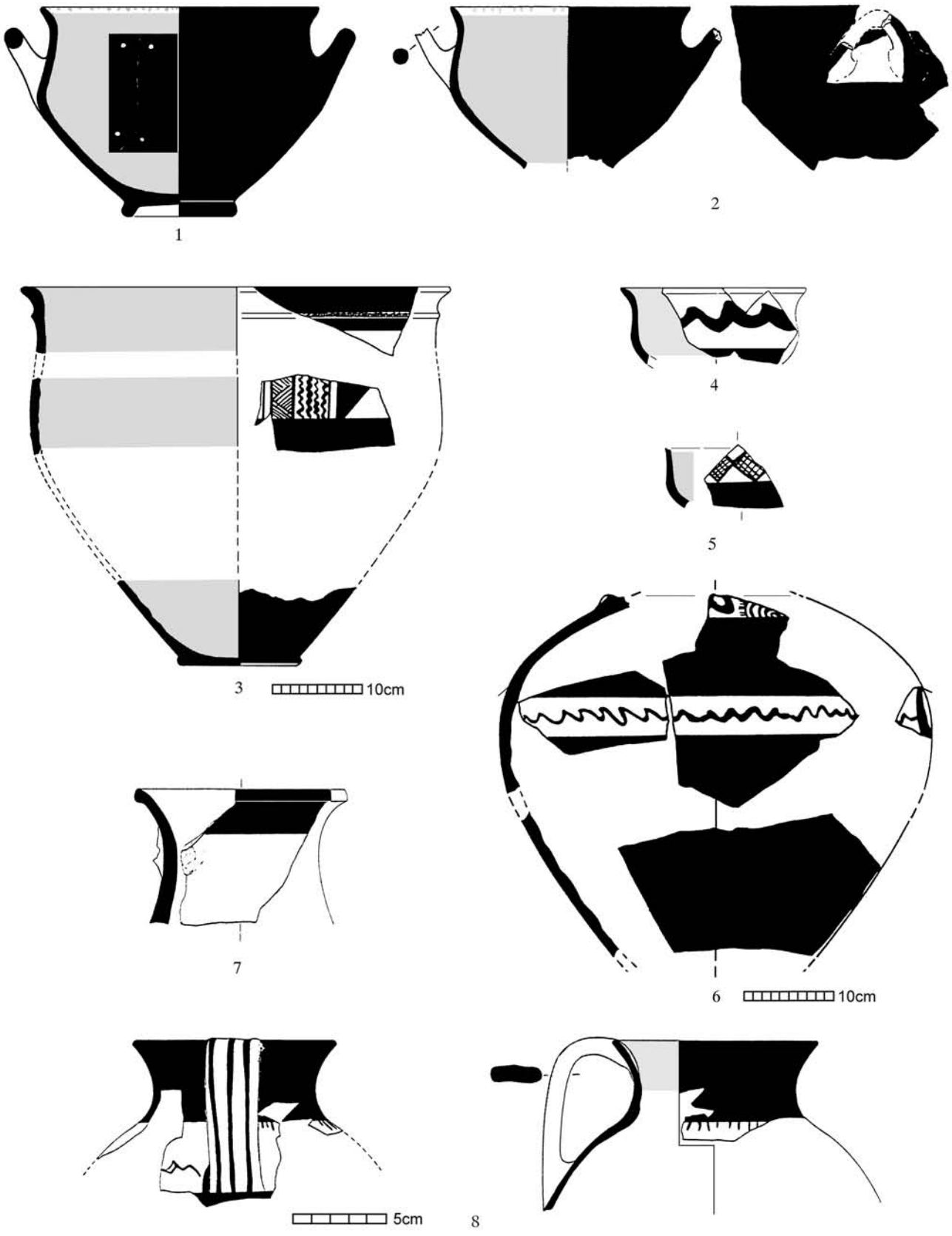

1-8 Punta Meliso (EBZ 2). 1-5. 7-8 M. 1:3; 3. 6 M. 1:6

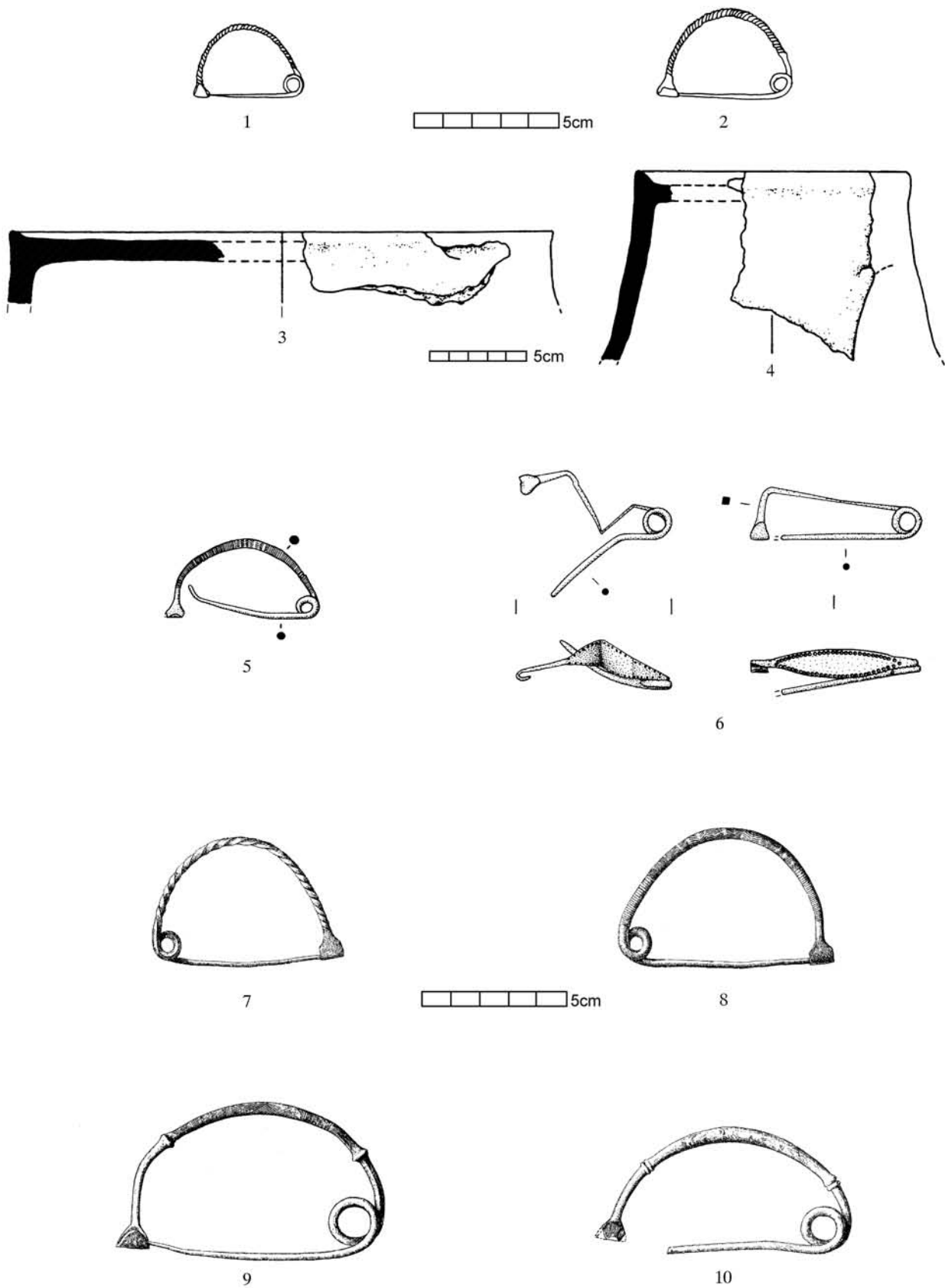

1-2 Frattesina, Hort I (EBZ 2); 3-4 Frattesina, Siedlung (EBZ); 5-6 Scarceta, Sektor D, Schicht II (EBZ 2);
7-8 Pantalica Nord, Grab 28; 9-10 Pantalica Südost, Grab 56. 1-2. 5-10 M. 1:2; 3-4 M. 1:3

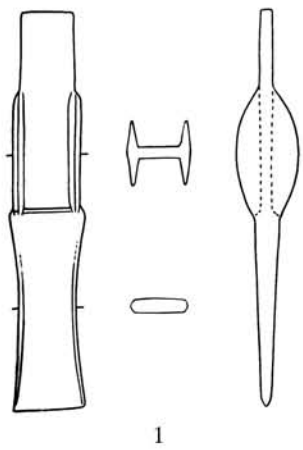

1

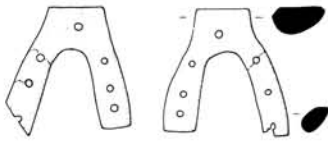

2

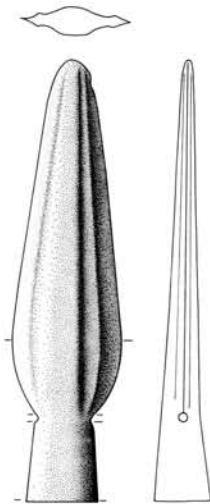

3

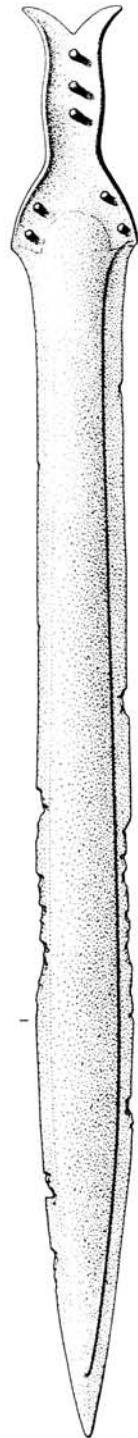

4

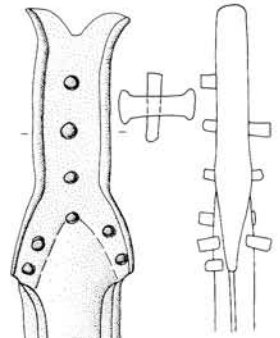

5

1-2 Mykene (SH III B Mitte); 3-4 Kos, Langádha, Grab 21; 5 Enkomi, Brunnen 212. M. 1:3

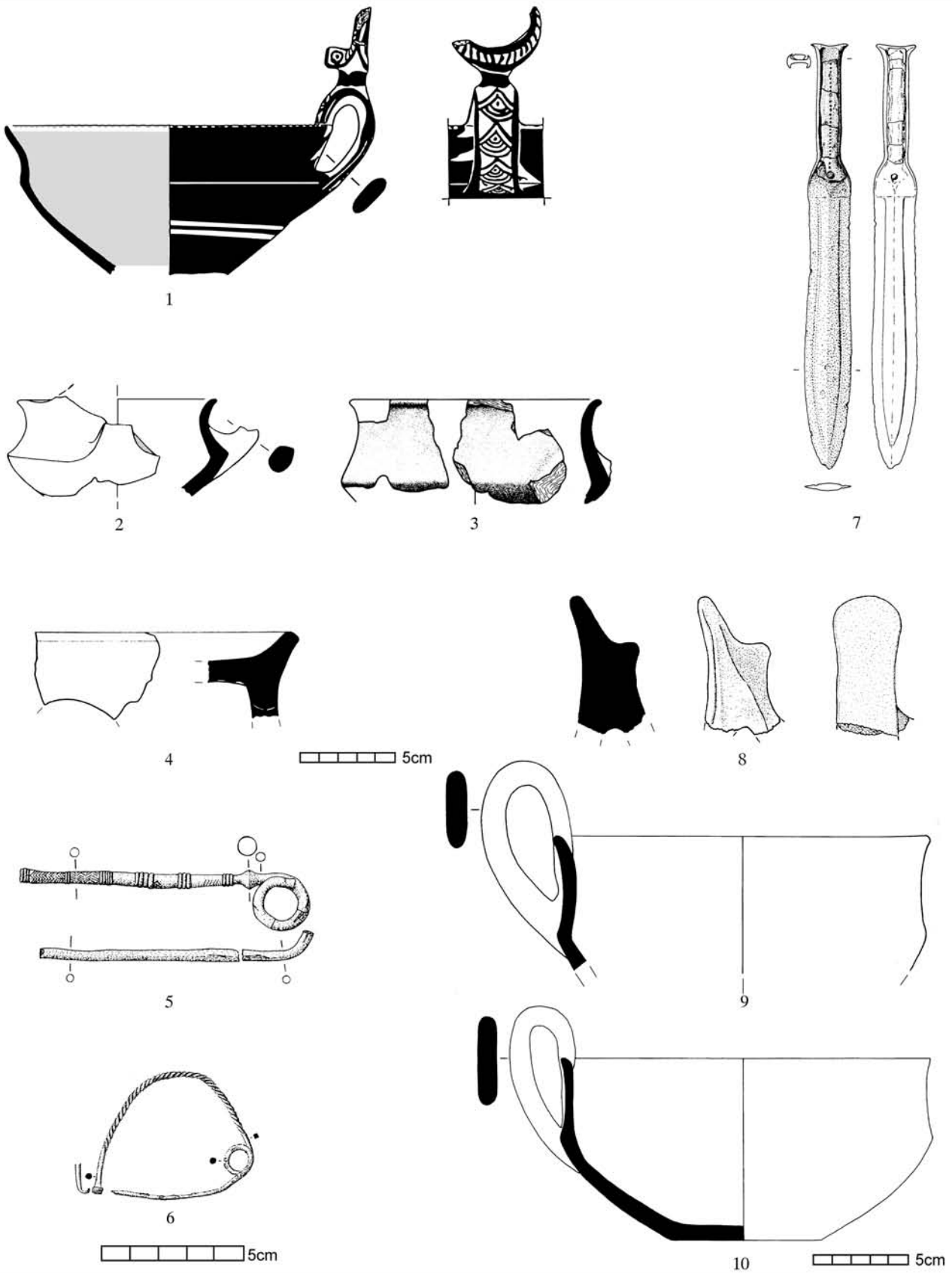

1-6 Tiryns; 7 Nemea (SH IIIB Früh/Mitte); 8-10 Chaniá. 1-4. 7-10 M. 1:3; 5-6. M. 1:2

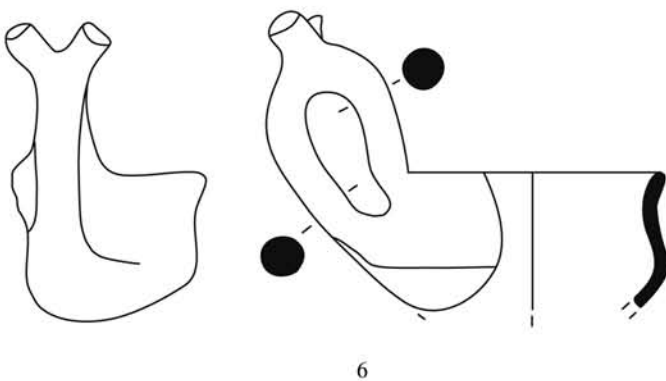
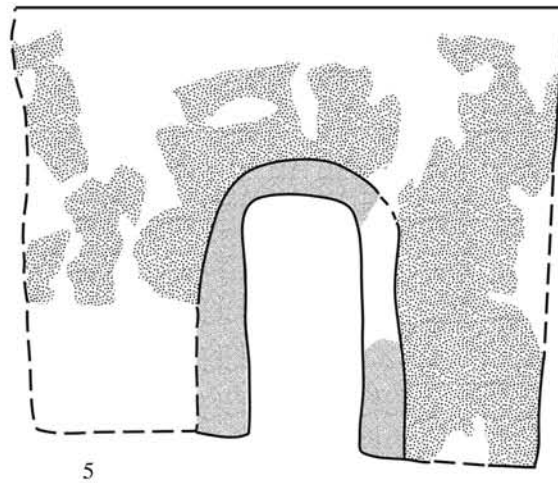
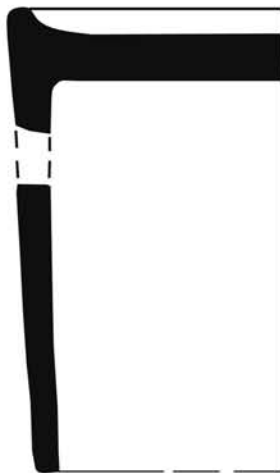
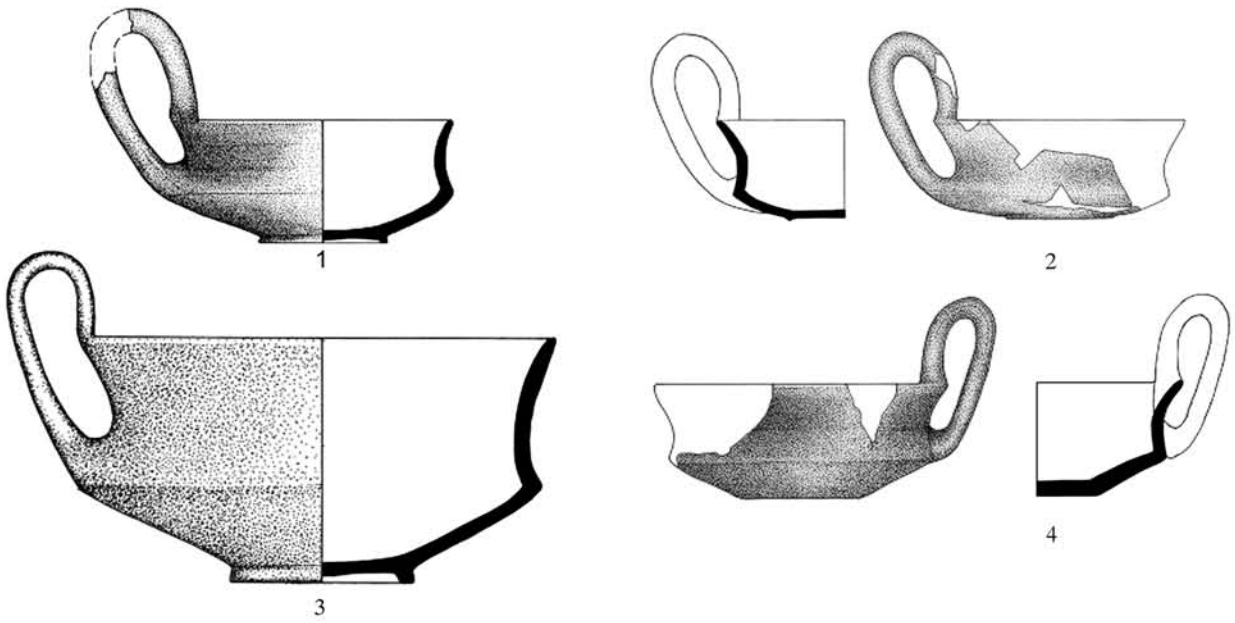

5cm

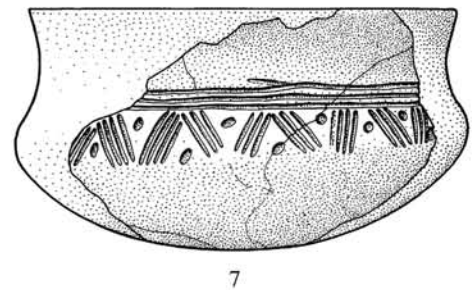

1-6 Dhimíni (SH IIIC Früh); 7 Vólos, Paliá. 1-6 M. 1:3; 7 ohne M.

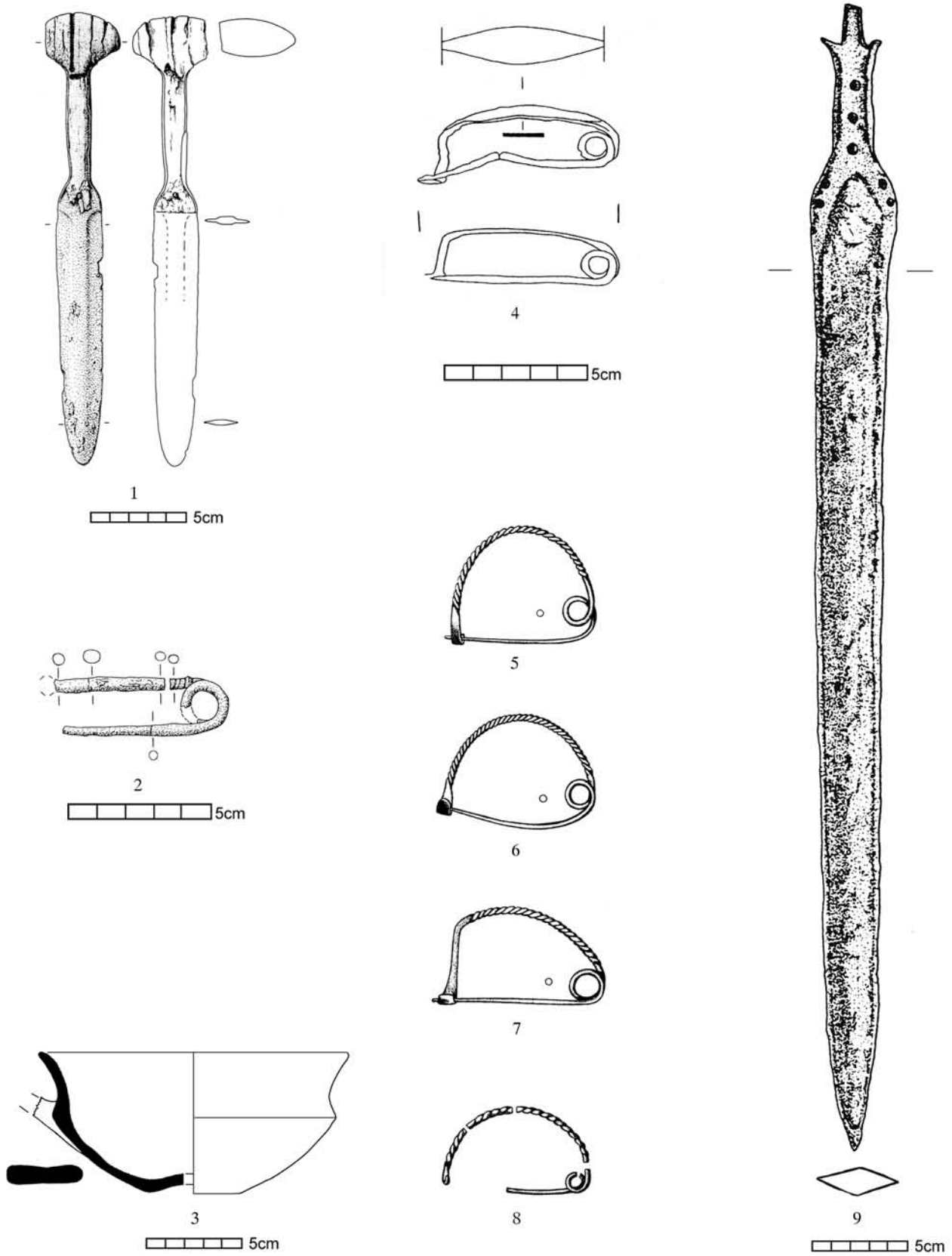

1 Teichos Dymaion (SH IIIC Früh); 2 Íria (SH IIIC Früh); 3 Lefkandí, Phase 1a (SH IIIC Früh);
 4 Kallithéa, Kammergrab Θ; 5–8 Kerameikos, Gräber (Submykenisch); 9 Kríni. 1. 3. 9 M 1:3; 2. 4–8 M. 1:2

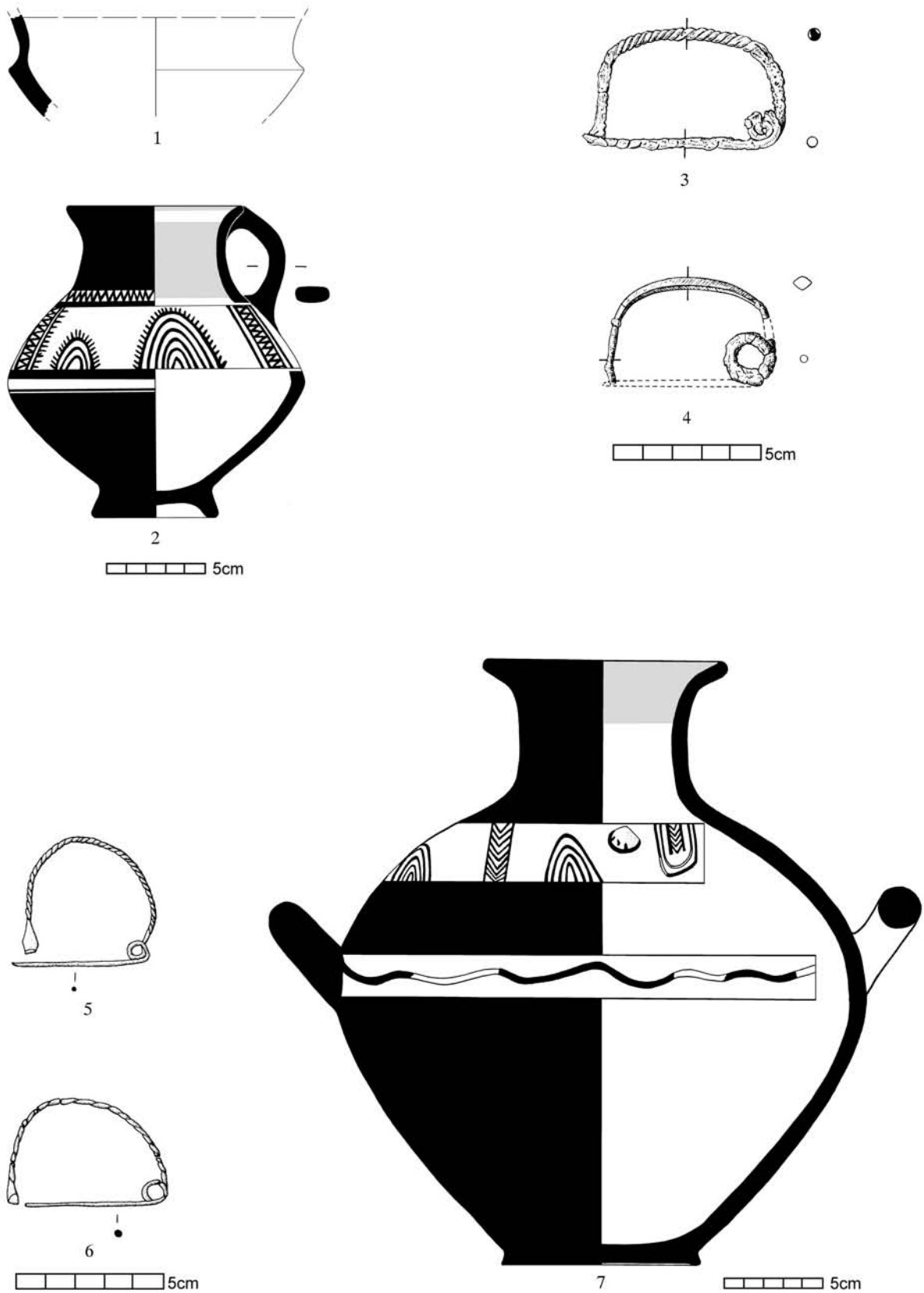

1 Korákou (SH IIIC Fortgeschritten); 2 Lastéika; 3 Peratí, Kammergrab 74, letzte Bestattung (SH IIIC Spät);
4 Peratí, Kammergrab 36; 5–7 Elis, Gräber (Submykenisch). 1. 2. 7 M. 1:3; 3–6 M. 1:2

TAFEL 20



1



2

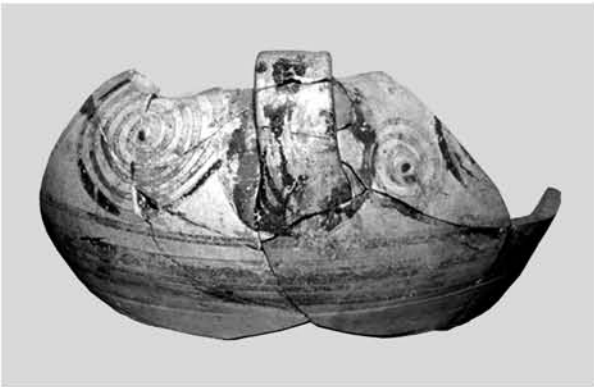

3



4



5

1 Lipari, Akropolis (Capo Graziano 2); 2 Lipari, Akropolis (Milazzese); 3 Panarea, Kap Milazzese (Milazzese); 4-5 Argos, Brandgrab, Urne Nr. 14. 1. 3 ca. M. 1:2; 2. 5 M. 1:3; 4 M. 1:2

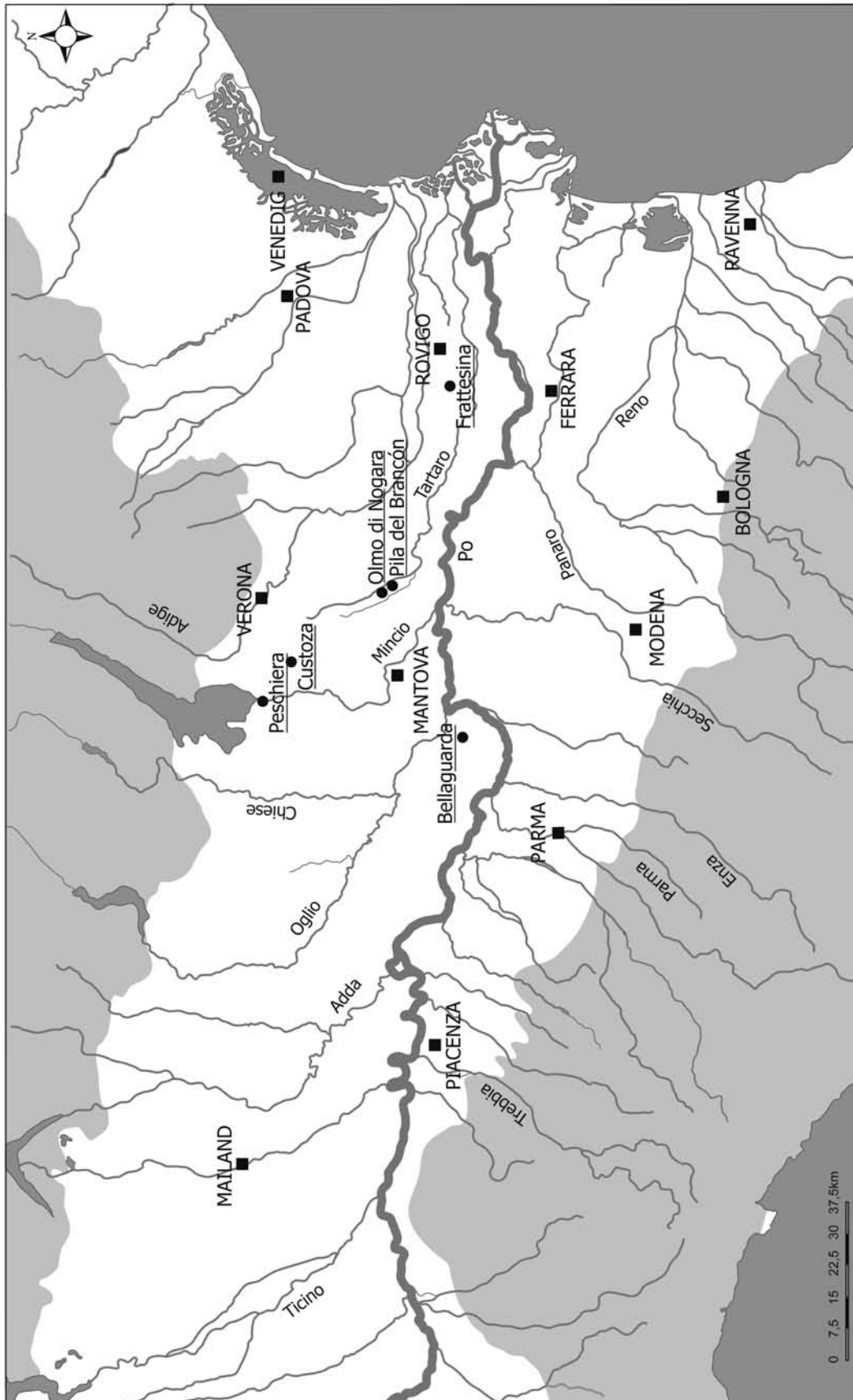

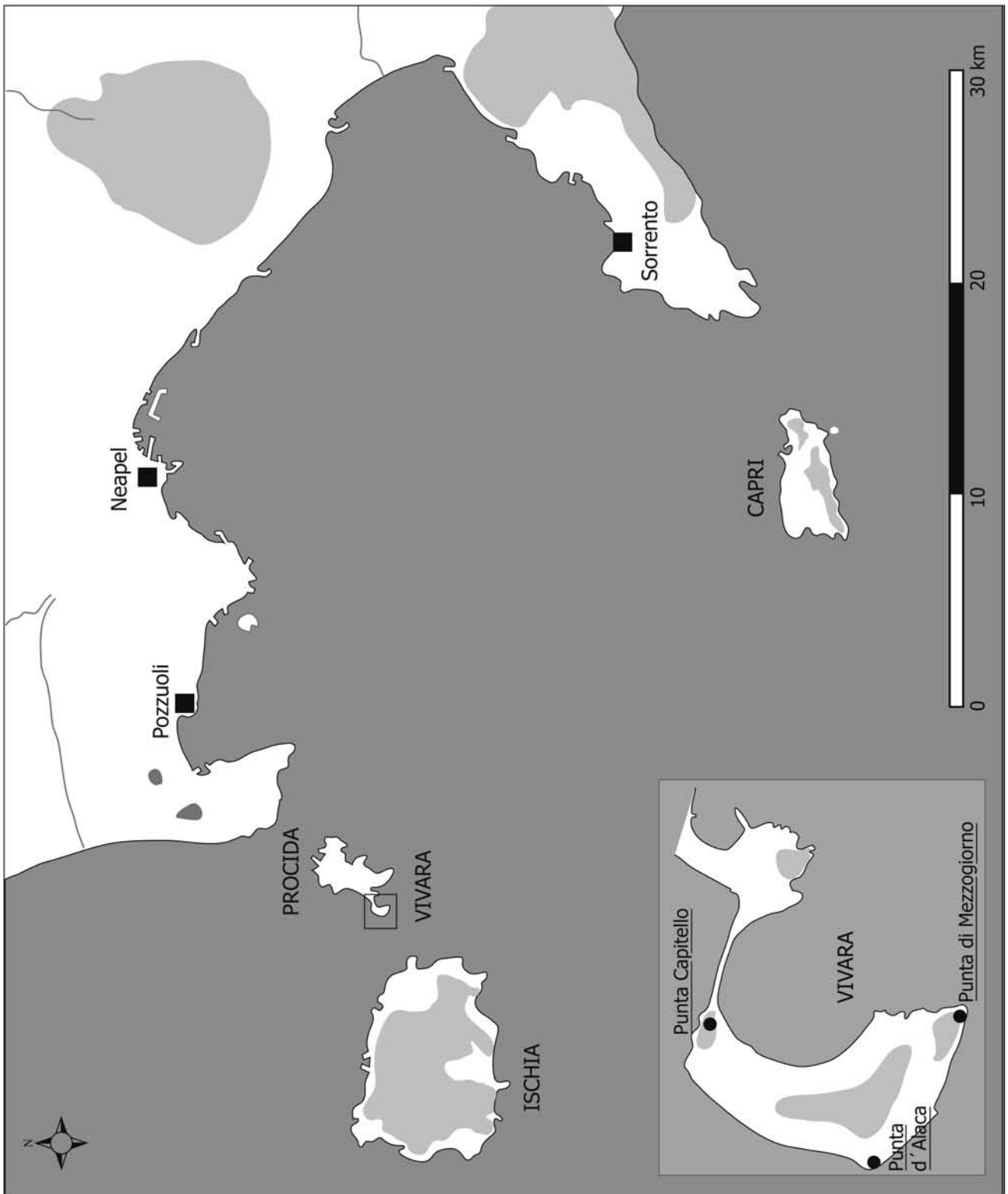

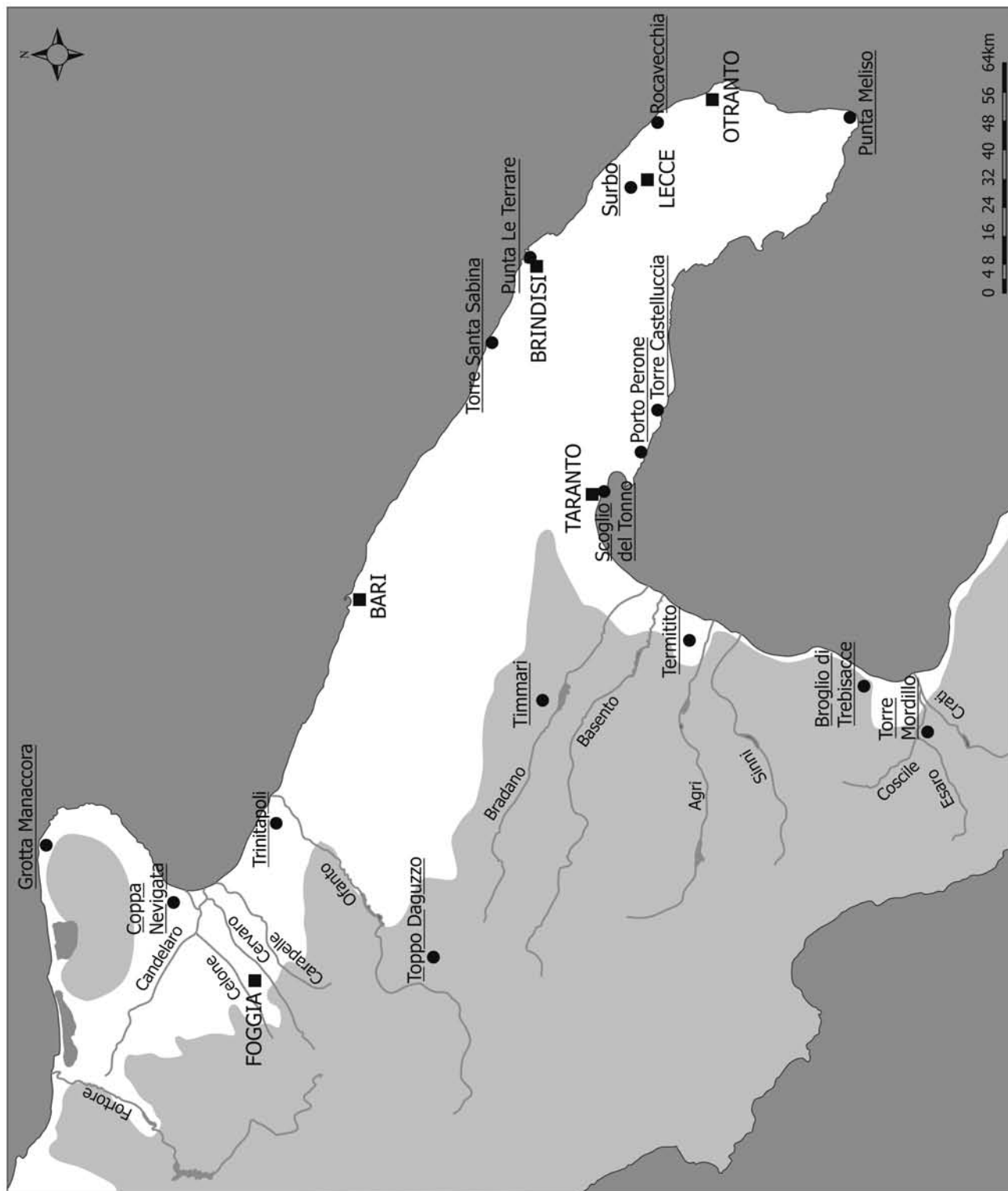

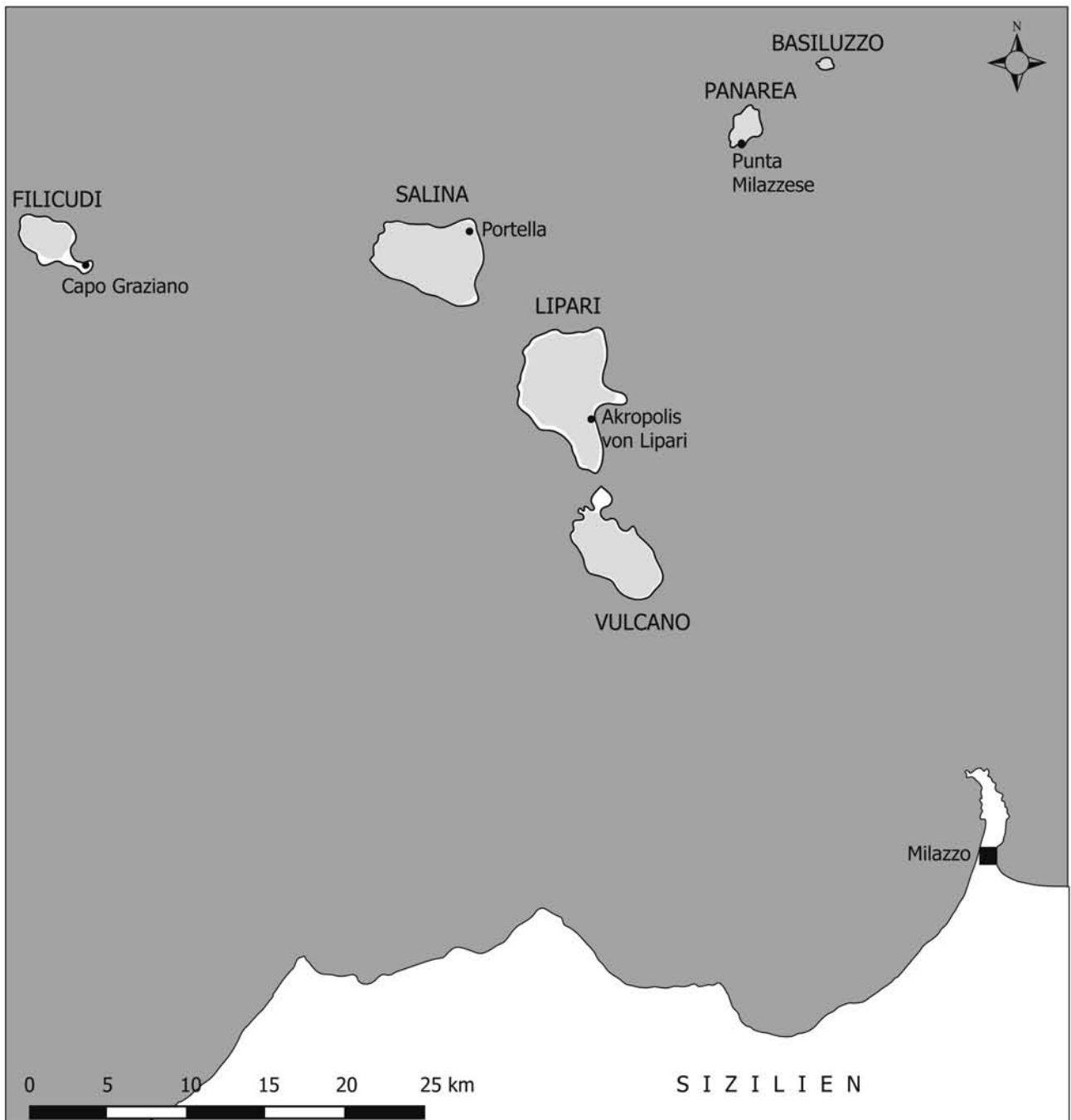

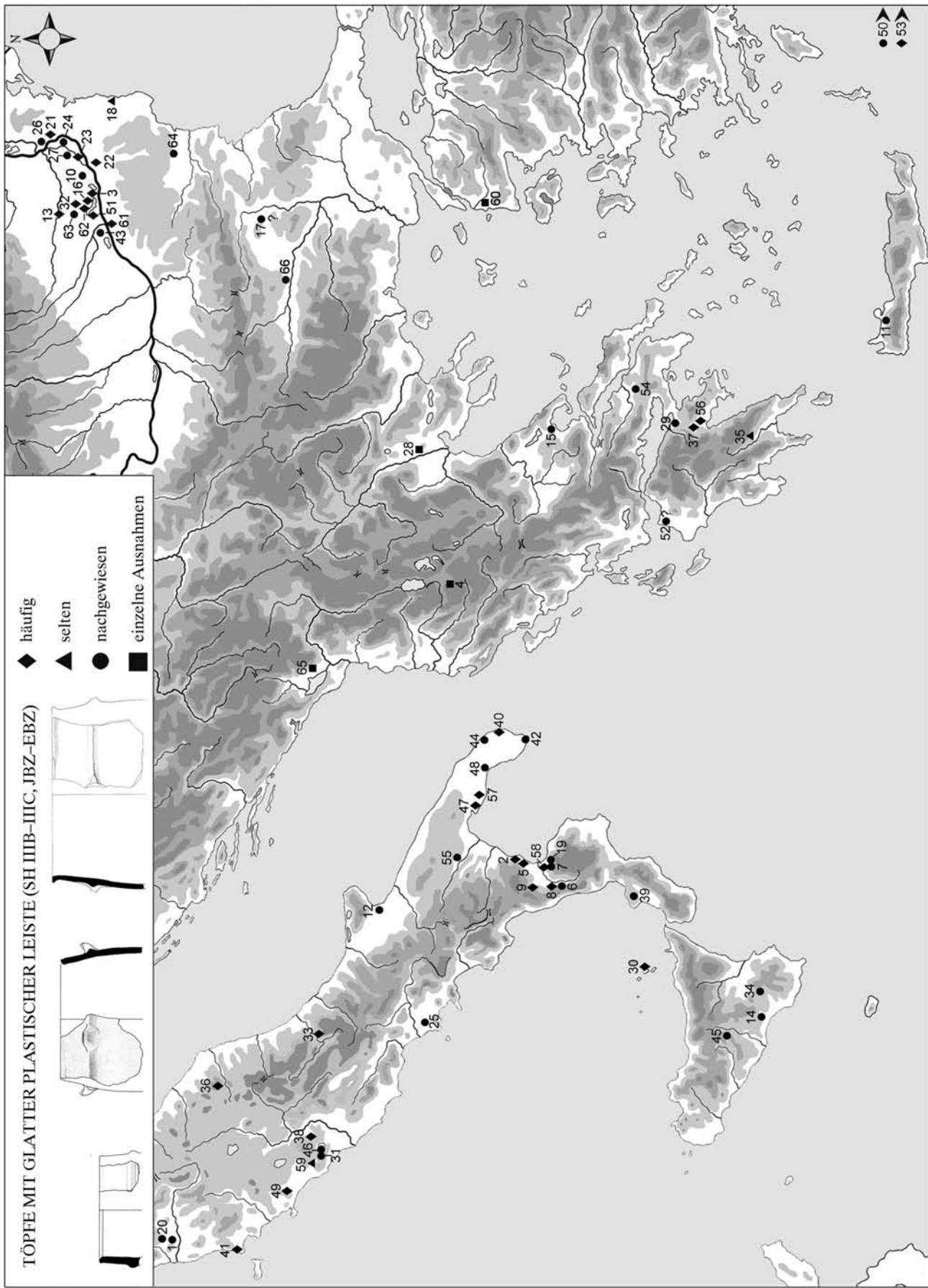

Handgemachte Geglättete Keramik (HGK) des SH IIIB–IIIC in Süd- und Zentralgriechenland (einschließlich Thessaliens, ohne Nordwestgriechenland) sowie in Westkleinasien

- ◆ italienische Typen ▲ sardische Typen
- nicht italienische sowie nicht zuweisbare Typen

